

## PC

**Button type Photoelectric cell.** To be mounted on the pole or on the luminaire base. Standard mounting height at 2" from the top of the pole.

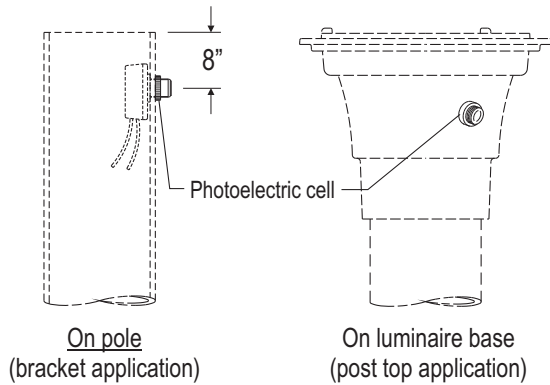
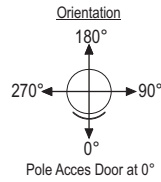

## PT / PX

**#PT:** Orientable **Twist Lock Photoelectric cell**, mounted on a cast aluminum cap for 4"Ø or 5"Ø poles.  
**#PX:** Shorting Cap

Hardware: Stainless steel set screws.

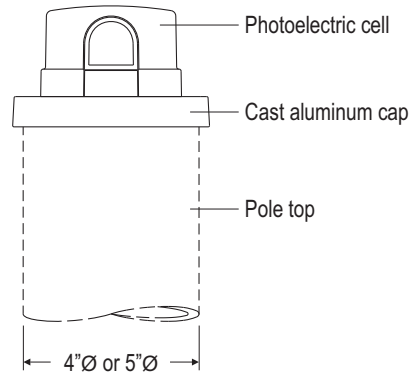

## PCD

**Button type Photoelectric cell** mounted on a removable door c/w captive screws.

Hardware: Stainless steel screws.

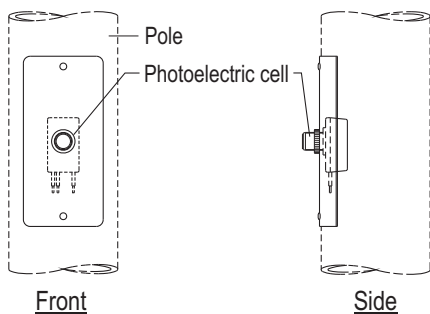
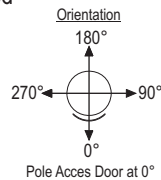

## DU / GFI

**#DU:** Duplex receptacle c/w weatherproof cover mounted on a cast aluminum adapter. Standard mounting height at 18" from the top of the pole.

**#GFI:** DU with Ground Fault Interrupter.

Hardware: Stainless steel screws.

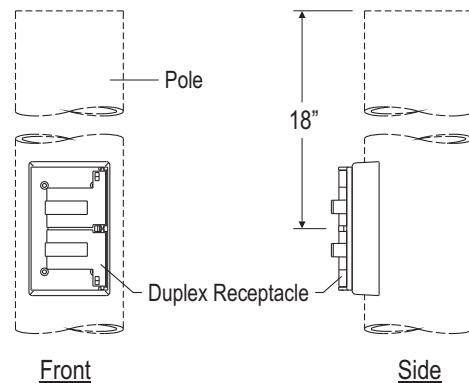
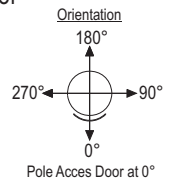



# Banner Arms



## MODELS

**BA:** Adjustable & removable banner arm with clamps & decorative cast aluminum finial

**BH:** Permanent banner arm

**BHB:** Permanent break-away banner arm

Hardware: Stainless steel bolts

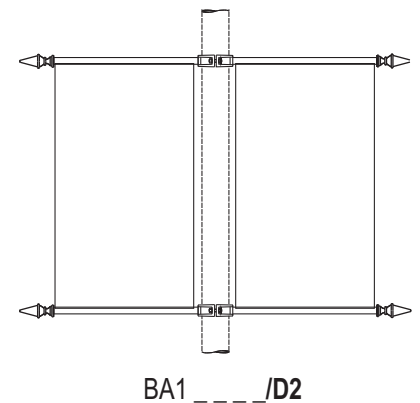
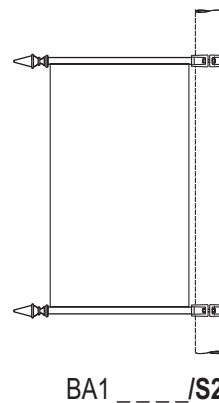
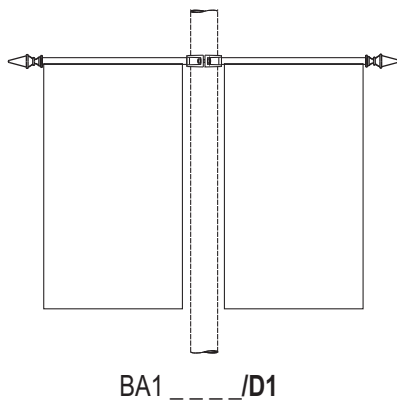
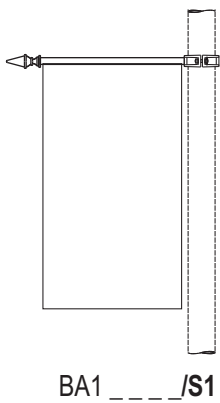
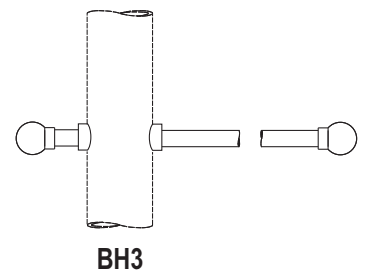
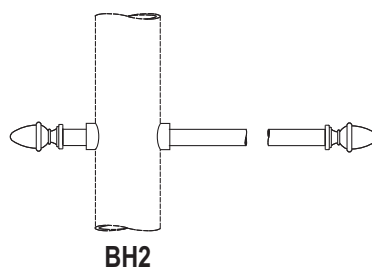
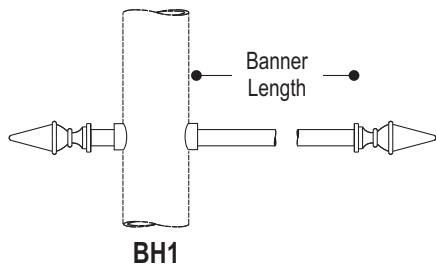
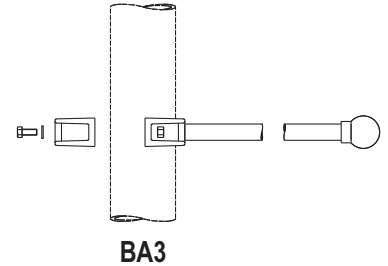
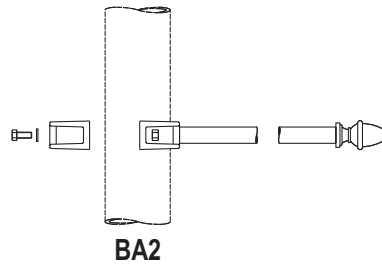
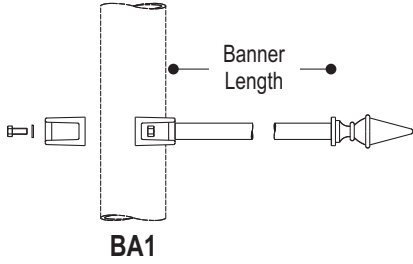

Example: **BA1 4 20 A P / S1**

Banner arm #: BA1  
 Pole diameter (in): 4  
 Banner length (in): 20  
 Finial material: A= Aluminum  
 B= Brass

Configuration: S1=Single  
 S2=Single (top&bottom)  
 D1=Double  
 D2=Double (top&bottom)

Finial finish: P= Painted  
 M= Polished "Mirror finish"  
 B= Polished "Brushed finish"

**BP\_:** Adjustable Plant Support with cast aluminum clamps, bent arm & round hook. Cast aluminum finial.

Hardware: Stainless steel bolts  
**60lbs/26kg max for 24" long.**

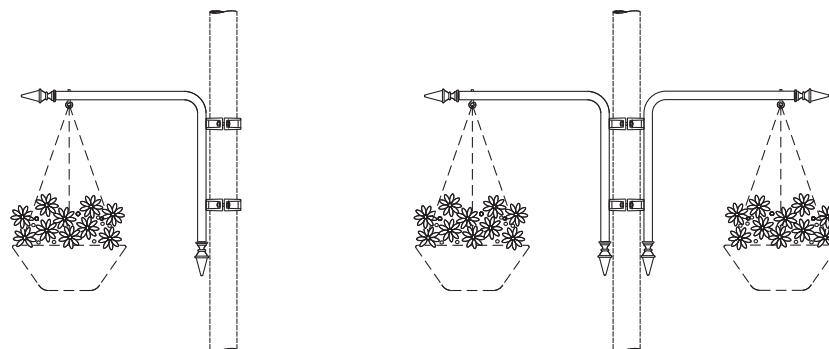
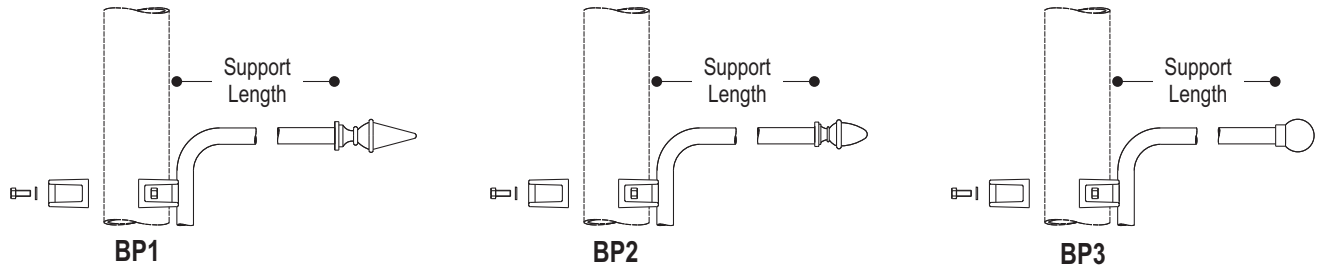

BP1 \_\_\_ /S1

BP1 \_\_\_ /D1

**Example: BP1 4 20 A P / S1**

Plant support #: BP1  
 Pole diameter (in): 4  
 Support length (in): 20  
 Finial material: A= Aluminum, B= Brass  
 Finial finish: P= Painted, M= Polished "Mirror finish", B= Polished "Brushed finish"  
 Configuration: S1=Single, D1=Double

## EYELET SUPPORTS

**BO:** Adjustable clamps with eye bolts

Hardware: Stainless steel bolts

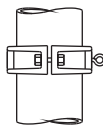

BO /S1

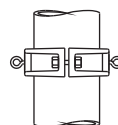

BO /D1

## MODELS

**BR:** Adjustable decorative aluminum ladder rest with clamps & cast aluminum finial

Hardware: Stainless steel bolts

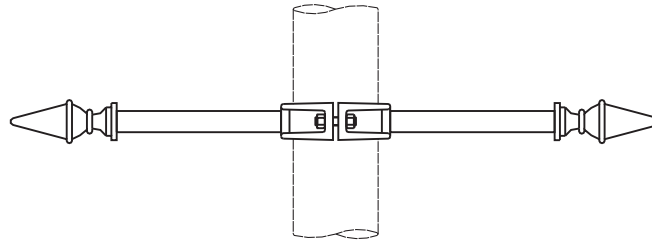

BR1\_ \_ \_

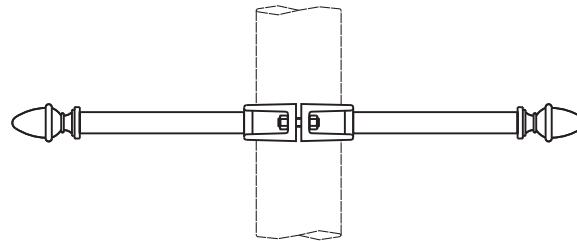
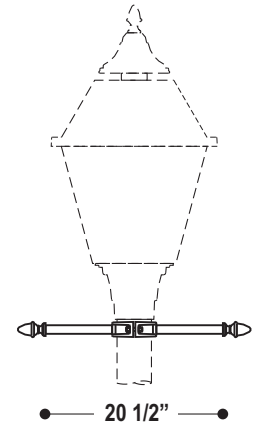

BR2\_ \_ \_

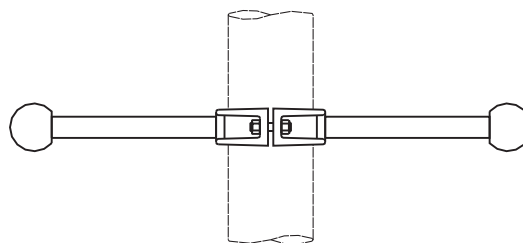

BR3\_ \_ \_

Example: **BR1 4 A P**

Ladder rest # : \_\_\_\_\_

Pole diameter (in) : \_\_\_\_\_

Finial material: A= Aluminum  
B= Brass

Finial finish: P= Painted

M= Polished "Mirror finish"

B= Polished "Brushed finish"