

ARMS, POLE AND BASES

This section showcases a vast assortment of mounting arms, poles, and bases. Poles are available in steel or aluminum, with varying wall thickness. Whether classic, traditional or contemporary styling, Cyclone mounting arms, poles and bases combos bring versatility to all types of projects.

MOUNTING ARMS / POST-TOP

Standard Configurations:

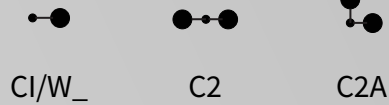

Other configurations available as Custom Project.

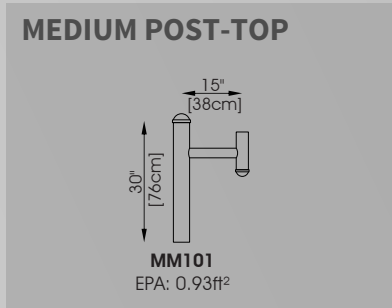
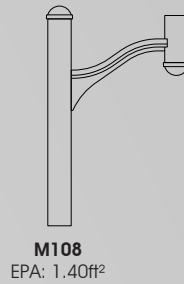
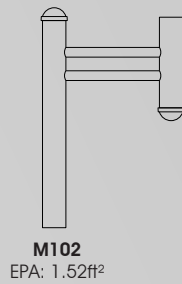
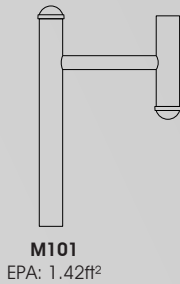

MOUNTING ARMS / SIDEMOUNT

Standard Configurations:

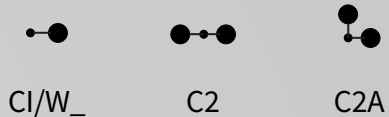

Other configurations available as Custom Project.

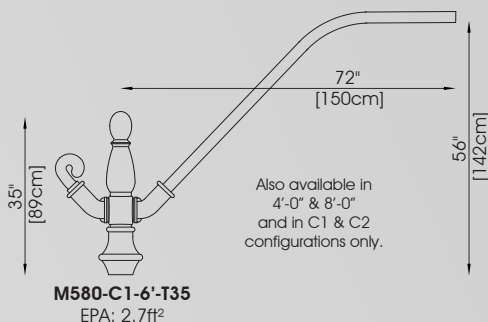
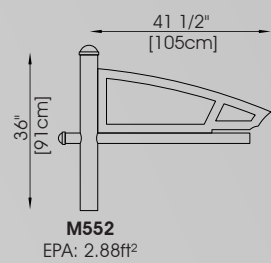
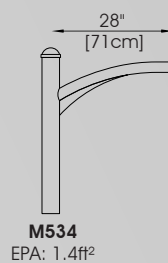
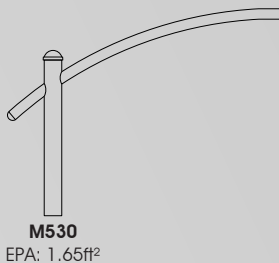
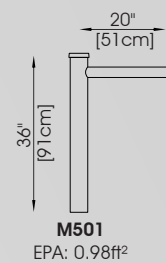

MEDIUM SIDEMOUNT

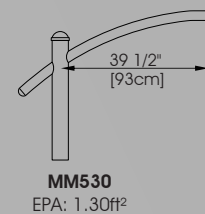
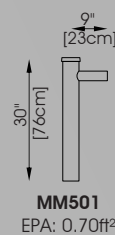

MOUNTING ARMS / PENDANT

Standard Configurations:

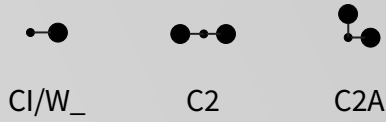

Other configurations available as Custom Project.

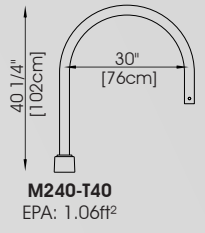
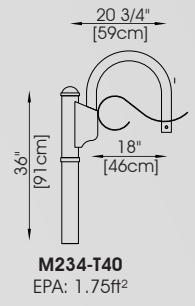
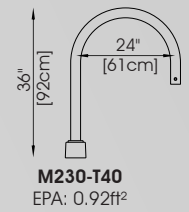
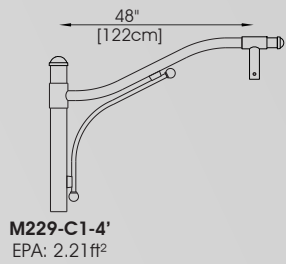
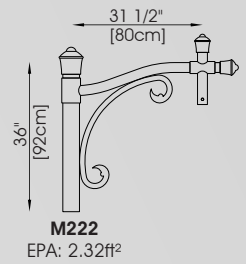
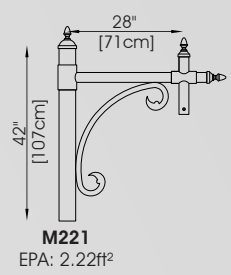
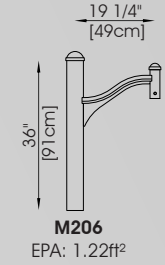
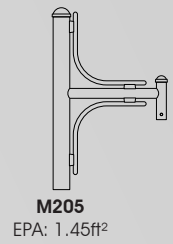
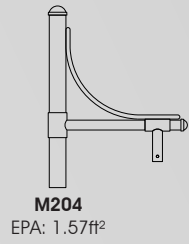
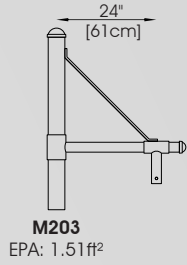
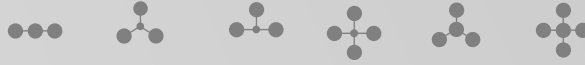

MEDIUM PENDANT

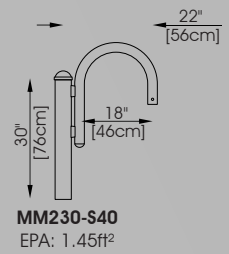
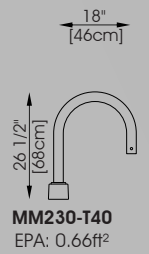
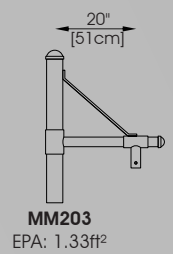

CANOPY

Available from 4" to 48" long.

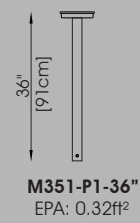

MOUNTING ARMS / BRACKET

Ordering template

Bracket Configuration Mounting Options Color

EXAMPLE: M101 C1 T40 NONE BLACK-TX

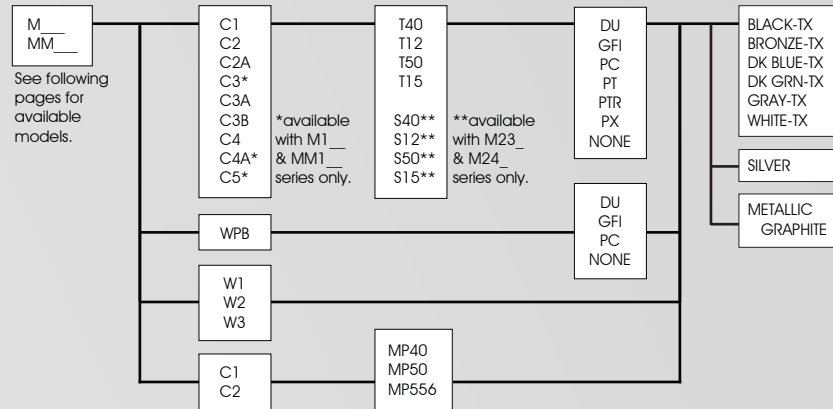

MOUNTING ATTACHEMENTS

See next pages for further details.

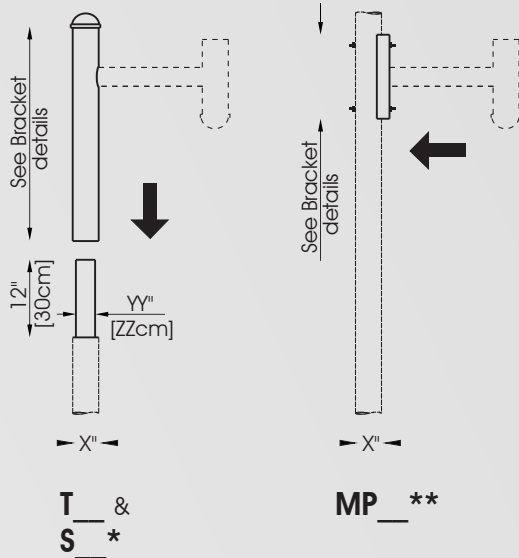

*For M23_ & M24_ series only.

**Available in C1 & C2 configuration only.

CONFIGURATION (WALL & WOOD POLE)

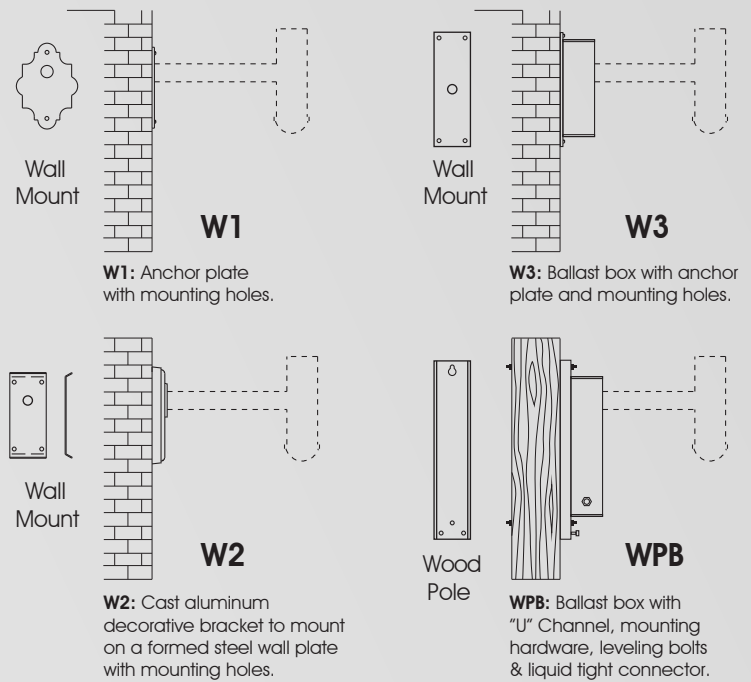

FINISH / OPTIONS

5mils/127microns polyester super durable powder coating.
A wide variety of RAL colors are available in textured (TX) or smooth (SM) finish.

Options (Not available with W1, W2, W3 & WP configuration)

- DU: Duplex receptacle.
- GFI: Ground fault Duplex receptacle.
- PC: Button type photocell.
- PT: Twistlock Photocell.
- PTR: Twistlock Photocell Receptacle.
- PX: Shorting cap.

OVERLAP TENON

The bracket slip fits on the pole tenon, secured by six set screws at 120 deg.

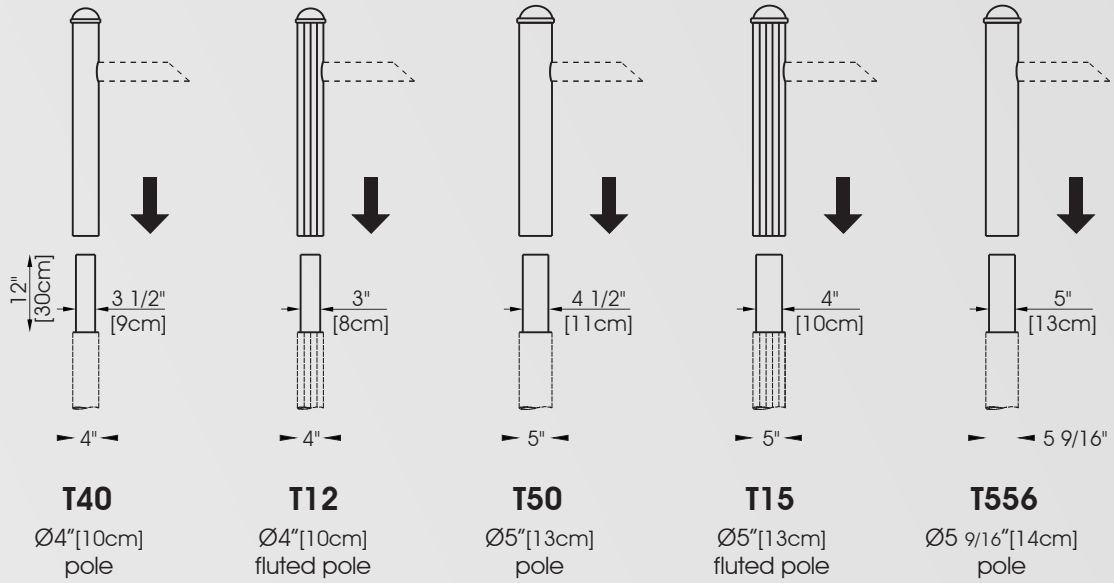

MIDPOLE *

The bracket is mechanically secured on the pole with two threaded rods, washer & nuts.

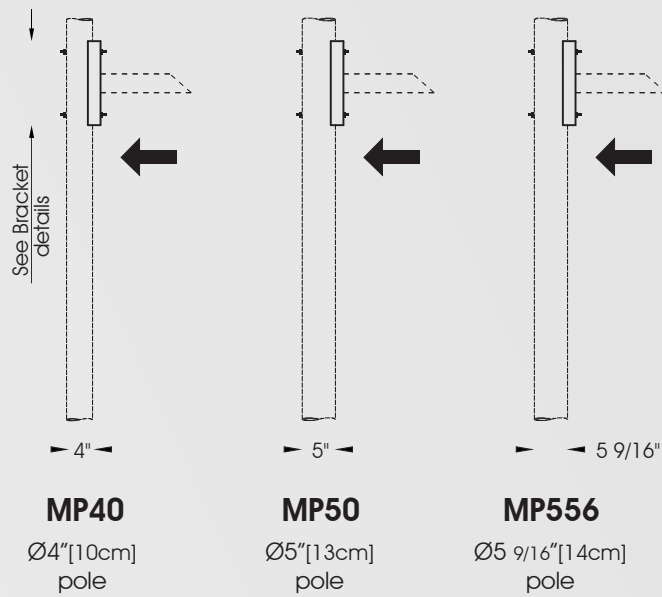

* Available in C1 & C2 configuration only.

INSIDE TENON (M23_ & M24_ SERIES ONLY)

The bracket slip fits on the pole tenon, secured by six set screws at 120 deg.

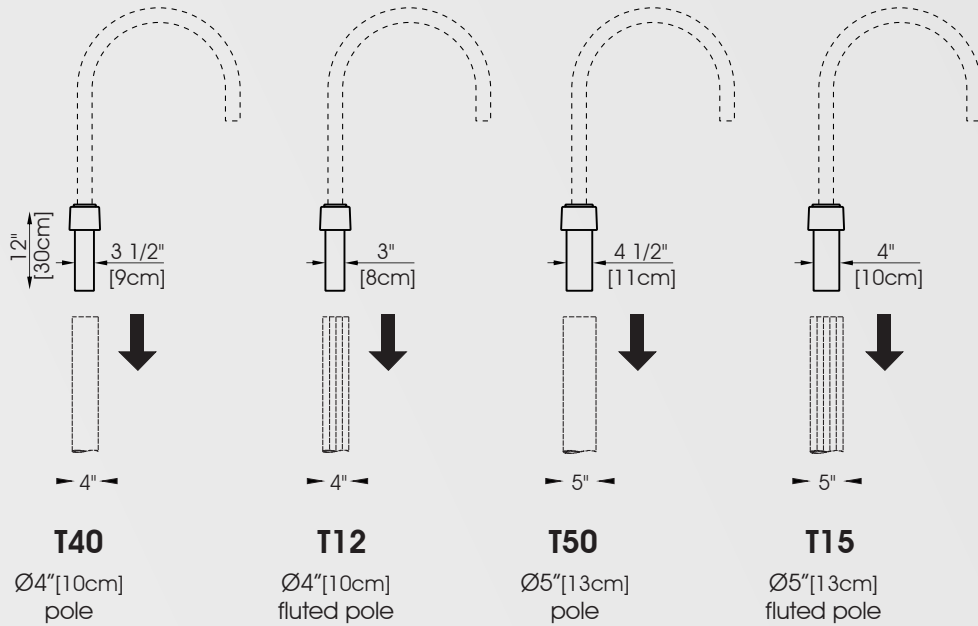

OVERLAP TENON - SIDE MOUNT ARM (M23_ & M24_ SERIES ONLY)

The "Goose neck" arm is welded with blocks on the side of the overlap tenon.
The bracket slip fits on the pole tenon, secured by six set screws at 120 deg.

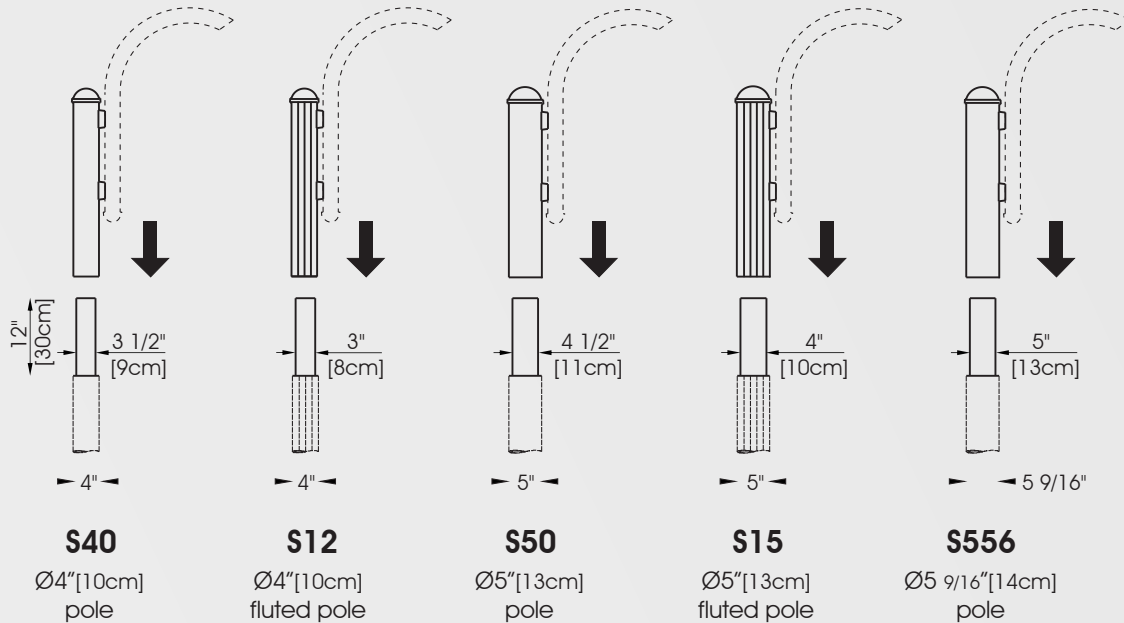

Due to continuous improvement, Cyclone reserves the right to modify these specifications, design and materials of these products without prior notice.



ARMS, POLE AND BASES

This section showcases a vast assortment of mounting arms, poles, and bases. Poles are available in steel or aluminum, with varying wall thickness. Whether classic, traditional or contemporary styling, Cyclone mounting arms, poles and bases combos bring versatility to all types of projects.

POLE GUIDE / ANCHORAGE

**Anchor Plate
(SA)**

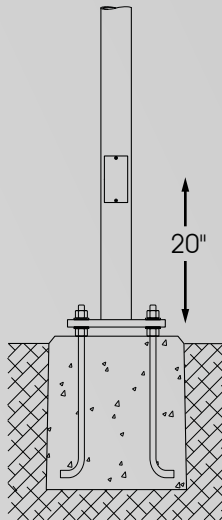

Pole with anchor plate for 3/4"(1.9mm) or 1"(25mm)Ø bolts.

**Pier mount
(SAP)**

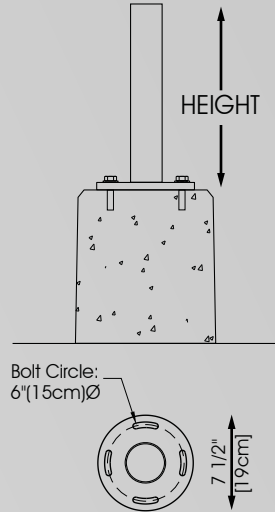

Pole with small anchor plate for 3/8"(10mm)Ø bolts.

**Steel tenon base
(TB4/TB5/TB6)**

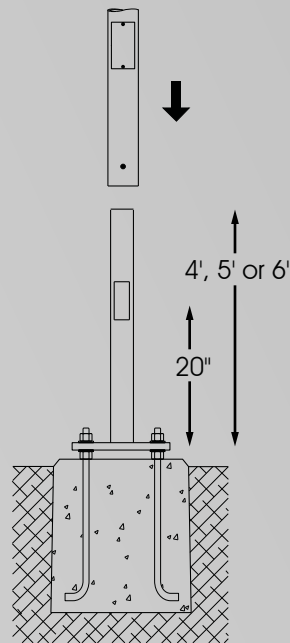

Pole shaft slip fits over and is secured with bolts to a steel tenon base c/w anchor plate for 3/4"(1.9mm) or 1"(25mm)Ø bolts.

**Direct burial
(DB5/DB6)**

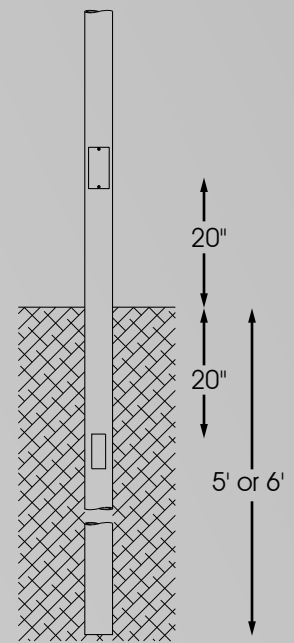

Buried pole (without anchor plate) with one (1) STD access door and two (2) wire holes placed opposite to each other.

Please consult factory for the specification sheet.

FINISH / OPTIONS

5mils/127microns polyester super durable powder coating.
A wide variety of RAL colors are available in textured (TX) or smooth (SM) finish.

Options

- BA_: Removable banner arm on clamp.
- BAB_: Removable banner arm, Break-away type, on clamp.
- BH_: Banner arm on a permanent sleeve on pole.
- BP_: Removable plant support on clamp c/w one eyelet.
- DU: Duplex receptacle.
- GFI: Ground fault Duplex receptacle.
- FH10: Removable flag holder on clamp.
- FU: Fuse and In-Line fuse holder.
- PC: Button type photocell.
- PCD: Button type photocell on a removable access door.
- TP: Tamperproof hardware.

ORDERING TEMPLATE

| | POLE | HEIGHT | ANCHORAGE | BASE COVER | OPTIONS | COLOUR |
|----------|------|--------|-----------|------------|---------|----------|
| Example: | PA30 | 8 | SA | BS23 | NONE | BLACK-TX |

See first pages for codification details.

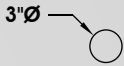

PA30 / PA32 - 3"Ø STRAIGHT POLE, ALUMINUM

POLE

Round, 3" (7cm)Ø, 6061-T6 aluminum shaft welded to both the top and bottom of a cast aluminum reinforced anchor plate. Hand hole 2" x 5" (8cm x 12cm) with weatherproof cover and copper ground lug. Square shape. Two-piece formed aluminum alloy 1100 base cover.

BASE COVER

BS15: Square shape. Two-piece formed aluminium alloy 1100 base cover. Mechanically secured together.
BD_: Round shape. Two-piece base cover made of cast aluminium. Mechanically secured together.

EPA

| | HEIGHT | | WALL THICKNESS | | WEIGHT | | EPA RATING (sq.ft) | | | | | | ANCHOR BOLTS |
|------|--------|------|----------------|-----|--------|----|--------------------|-------|--------|--------|--------|--------|--------------|
| | ft | m | in | mm | lbs | kg | 80mph | 90mph | 100mph | 110mph | 120mph | 150mph | in |
| PA30 | 8 | 2.44 | 0.125 | 3.2 | 12 | 5 | 7.0 | 5.3 | 4.1 | 3.2 | 2.5 | 1.3 | 3/4-20 |
| PA32 | 8 | 2.44 | 0.250 | 6.3 | 21 | 10 | 13.9 | 10.8 | 8.6 | 6.9 | 5.6 | 3.2 | 3/4-20 |
| PA30 | 10 | 3.05 | 0.125 | 3.2 | 15 | 7 | 5.1 | 3.8 | 2.8 | 2.1 | 1.6 | - | 3/4-20 |
| PA32 | 10 | 3.05 | 0.250 | 6.3 | 26 | 12 | 10.8 | 8.3 | 6.4 | 5.1 | 4.1 | 2.1 | 3/4-20 |
| PA30 | 12 | 3.66 | 0.125 | 3.2 | 17 | 8 | 3.7 | 2.6 | 1.8 | 1.2 | - | - | 3/4-20 |
| PA32 | 12 | 3.66 | 0.250 | 6.3 | 31 | 14 | 8.5 | 6.4 | 4.9 | 3.7 | 2.9 | 1.3 | 3/4-20 |

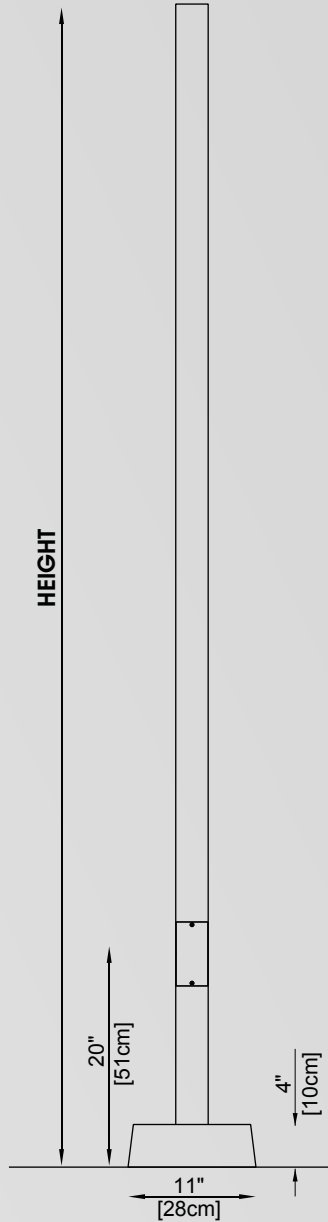

BOLT CIRCLE

Anchor plate (SA)

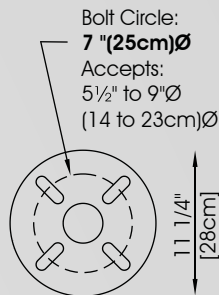

Pole with anchor plate, supplied with galvanized anchor bolts, nuts & washers.

ANCHORAGE

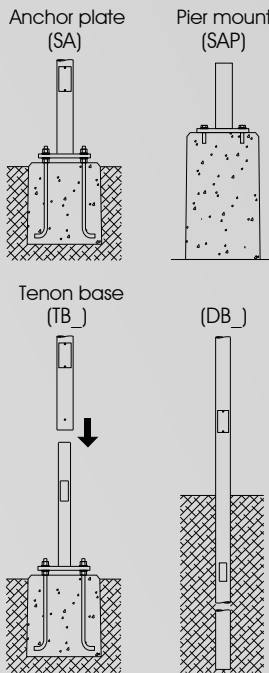

BASE COVERS (examples)

BS23 is shown with the pole.
 For all models available, see "Pole options" Section.

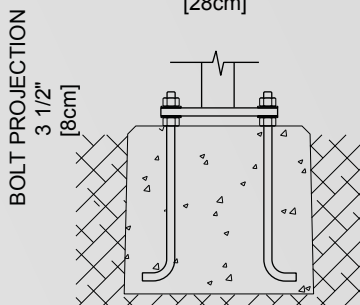
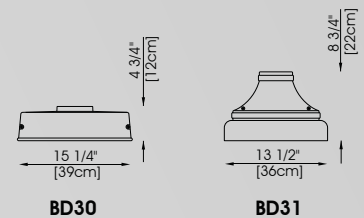

ORDERING TEMPLATE

| | POLE | HEIGHT | ANCHORAGE | BASE COVER | OPTIONS | COLOUR |
|----------|------|--------|-----------|------------|---------|----------|
| Example: | PA40 | 12 | SA | BS15 | NONE | BLACK-TX |

See first pages for codification details.

PA40 / PA42 - 4"Ø STRAIGHT POLE, ALUMINUM

POLE

Round, 4" (10cm)Ø, 6061-T6 aluminum shaft, welded to both the top and bottom of a cast aluminum reinforced anchor plate. Hand hole 2" x 5" (8cm x 12cm) with weatherproof cover and copper ground lug.

BASE COVER

BS15: Square shape. Two-piece formed aluminium alloy 1100 base cover. Mechanically secured together.
BD_: Round shape. Two-piece base cover made of cast aluminium. Mechanically secured together.

EPA

| | HEIGHT | | WALL THICKNESS | | WEIGHT | | EPA RATING (sq.ft) | | | | | | ANCHOR BOLTS |
|------|--------|------|----------------|-----|--------|----|--------------------|-------|--------|--------|--------|--------|--------------|
| | ft | m | in | mm | lbs | kg | 80mph | 90mph | 100mph | 110mph | 120mph | 150mph | in |
| PA40 | 8 | 2.44 | 0.125 | 3.2 | 19 | 9 | 13.6 | 10.4 | 8.2 | 6.5 | 5.3 | 3.3 | 3/4-20 |
| PA42 | 8 | 2.44 | 0.226 | 5.7 | 30 | 14 | 24.4 | 19.0 | 15.1 | 12.3 | 10.1 | 6.3 | 3/4-20 |
| PA40 | 10 | 3.05 | 0.125 | 3.2 | 23 | 10 | 10.4 | 7.9 | 6.0 | 4.7 | 3.7 | 2.2 | 3/4-20 |
| PA42 | 10 | 3.05 | 0.226 | 5.7 | 36 | 16 | 19.3 | 14.9 | 11.7 | 9.4 | 7.7 | 4.7 | 3/4-20 |
| PA40 | 12 | 3.66 | 0.125 | 3.2 | 27 | 12 | 8.1 | 5.9 | 4.4 | 3.3 | 2.5 | 1.4 | 3/4-20 |
| PA42 | 12 | 3.66 | 0.226 | 5.7 | 42 | 19 | 15.5 | 11.8 | 9.2 | 7.2 | 5.8 | 3.5 | 3/4-20 |
| PA40 | 13 | 3.96 | 0.125 | 3.2 | 29 | 13 | 7.1 | 5.1 | 3.7 | 2.7 | 2.0 | 1.1 | 3/4-20 |
| PA42 | 13 | 3.96 | 0.226 | 5.7 | 46 | 21 | 14.0 | 10.6 | 8.2 | 6.3 | 5.0 | 3.0 | 3/4-20 |
| PA40 | 14 | 4.27 | 0.125 | 3.2 | 31 | 14 | 6.2 | 4.4 | 3.1 | 2.1 | 1.5 | - | 3/4-20 |
| PA42 | 14 | 4.27 | 0.226 | 5.7 | 49 | 22 | 12.7 | 9.5 | 7.2 | 5.6 | 4.4 | 2.5 | 3/4-20 |
| PA40 | 15 | 4.57 | 0.125 | 3.2 | 32 | 15 | 5.4 | 3.7 | 2.5 | 1.6 | 1.0 | - | 3/4-20 |
| PA42 | 15 | 4.57 | 0.226 | 5.7 | 52 | 24 | 11.5 | 8.5 | 6.4 | 4.8 | 3.7 | 2.1 | 3/4-20 |
| PA40 | 16 | 4.88 | 0.125 | 3.2 | 34 | 15 | 4.7 | 3.1 | 2.0 | 1.2 | - | - | 3/4-20 |
| PA42 | 16 | 4.88 | 0.226 | 5.7 | 55 | 25 | 10.4 | 7.6 | 5.6 | 4.2 | 3.1 | 1.7 | 3/4-20 |
| PA42 | 18 | 5.49 | 0.226 | 5.7 | 61 | 28 | 8.2 | 5.9 | 4.2 | 2.9 | 2.0 | 1.0 | 1-36 |
| PA42 | 20 | 6.10 | 0.226 | 5.7 | 68 | 31 | 6.5 | 4.4 | 2.9 | 1.8 | 1.1 | - | 1-36 |

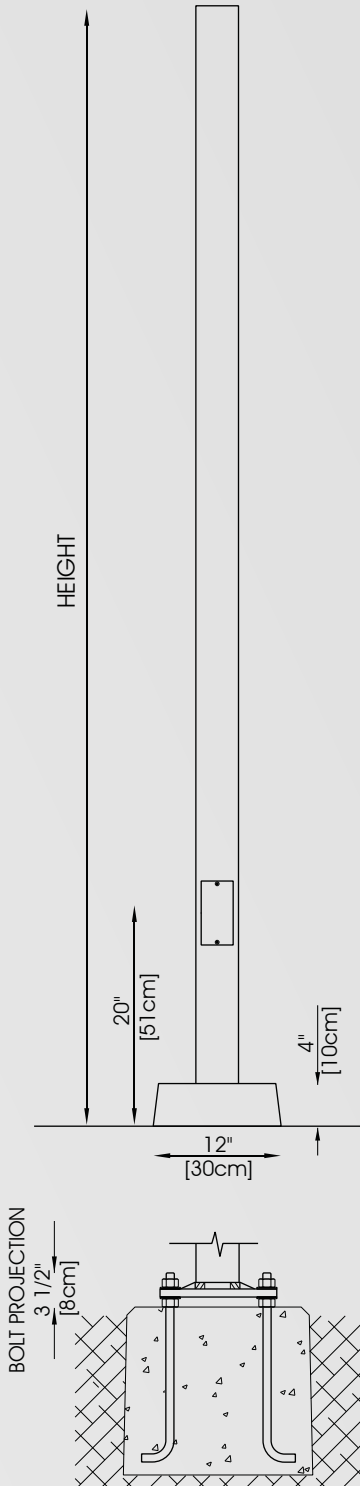
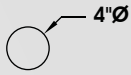

BOLT CIRCLE

Anchor plate (SA or TB_)

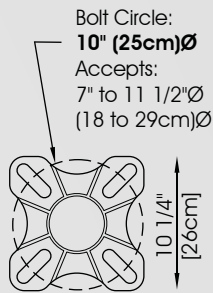

Pole with anchor plate, supplied with galvanized anchor bolts, nuts & washers.

ANCHORAGE

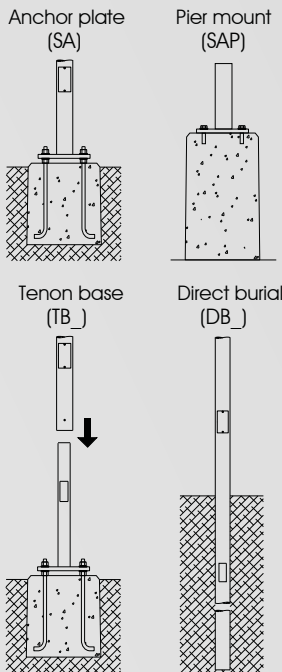

BASE COVERS (examples)

BS15 is shown with the pole.
 For all models available, see "Pole options" Section.

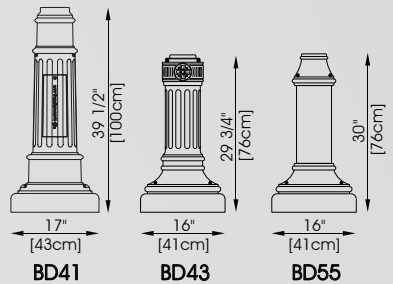

ORDERING TEMPLATE

| | POLE | HEIGHT | ANCHORAGE | BASE COVER | OPTIONS | COLOUR |
|----------|------|--------|-----------|------------|---------|----------|
| Example: | PS40 | 12 | SA | BS15 | NONE | BLACK-TX |

See first pages for codification details.

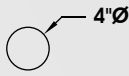

PS40 / PS42 - 4"Ø STRAIGHT POLE, STEEL

POLE

Round, 4" (10cm)Ø, high tensile strength, ASTM-A500 grade C steel shaft. Welded to both the top and bottom of an anchor plate.

Handhole 2" x 5" (8cm x 12 cm) with weatherproof cover and copper ground lug.

BASE COVER

BS15: Square shape. Two-piece formed aluminium alloy 1100 base cover. Mechanically secured together.

BD_: Round shape. Two-piece base cover made of cast aluminium. Mechanically secured together.

EPA

| | HEIGHT | | WALL THICKNESS | | WEIGHT | | EPA RATING (sq.ft) | | | | | | ANCHOR BOLTS |
|------|--------|------|----------------|-----|--------|----|--------------------|-------|--------|--------|--------|--------|--------------|
| | ft | m | in | mm | lbs | kg | 80mph | 90mph | 100mph | 110mph | 120mph | 150mph | in |
| PS40 | 8 | 2.44 | 0.120 | 3.0 | 58 | 26 | 31.3 | 24.4 | 19.5 | 15.9 | 13.2 | 8.3 | 3/4-20 |
| PS40 | 10 | 3.05 | 0.120 | 3.2 | 68 | 31 | 24.9 | 19.3 | 15.3 | 12.3 | 10.1 | 6.3 | 3/4-20 |
| PS40 | 12 | 3.66 | 0.120 | 3.0 | 79 | 36 | 20.3 | 15.6 | 12.2 | 9.8 | 7.9 | 4.8 | 3/4-20 |
| PS40 | 13 | 3.96 | 0.120 | 3.0 | 84 | 38 | 18.4 | 14.1 | 11.0 | 8.7 | 7.0 | 4.2 | 3/4-20 |
| PS42 | 13 | 3.96 | 0.250 | 6.3 | 147 | 67 | 38.3 | 29.8 | 23.7 | 19.2 | 15.8 | 9.9 | 3/4-20 |
| PS40 | 14 | 4.27 | 0.120 | 3.0 | 89 | 40 | 16.8 | 12.8 | 9.9 | 7.7 | 6.2 | 3.7 | 3/4-20 |
| PS42 | 14 | 4.27 | 0.250 | 6.3 | 157 | 71 | 35.3 | 27.4 | 21.7 | 17.5 | 14.4 | 9.0 | 3/4-20 |
| PS40 | 15 | 4.57 | 0.120 | 3.0 | 94 | 43 | 15.3 | 11.6 | 8.9 | 6.9 | 5.4 | 3.2 | 3/4-20 |
| PS42 | 15 | 4.57 | 0.250 | 6.3 | 167 | 76 | 32.6 | 25.2 | 20.0 | 16.0 | 13.1 | 8.1 | 3/4-20 |
| PS40 | 16 | 4.88 | 0.120 | 3.0 | 99 | 45 | 14.0 | 10.5 | 8.0 | 6.1 | 4.8 | 2.7 | 3/4-20 |
| PS42 | 16 | 4.88 | 0.250 | 6.3 | 177 | 80 | 30.2 | 23.3 | 18.3 | 14.7 | 12.0 | 7.4 | 3/4-20 |
| PS40 | 18 | 5.49 | 0.120 | 3.0 | 110 | 50 | 11.2 | 8.1 | 6.0 | 4.3 | 3.2 | 1.7 | 1-36 |
| PS42 | 18 | 5.49 | 0.250 | 6.3 | 197 | 89 | 25.3 | 19.3 | 15.0 | 11.8 | 9.5 | 5.7 | 1-36 |
| PS40 | 20 | 6.10 | 0.120 | 3.0 | 120 | 54 | 8.8 | 6.2 | 4.2 | 2.8 | 1.9 | 0.8 | 1-36 |
| PS42 | 20 | 6.10 | 0.250 | 6.3 | 217 | 98 | 21.2 | 15.9 | 12.2 | 9.4 | 7.4 | 4.3 | 1-36 |



BOLT CIRCLE

Anchor plate (SA)

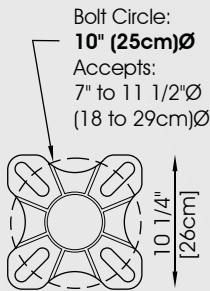

ANCHORAGE

Anchor plate (SA)

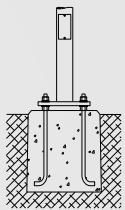

Direct burial (DB_)

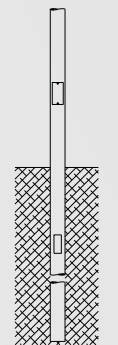

BASE COVERS (examples)

BS15 is shown with the pole.

For all models available, see "Pole options" Section.

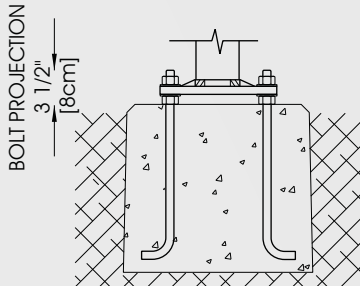
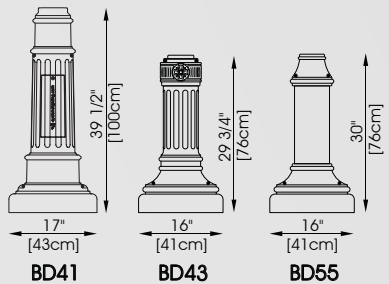

Pole with anchor plate, supplied with galvanized anchor bolts, nuts & washers.

ORDERING TEMPLATE

| | POLE | HEIGHT | ANCHORAGE | BASE COVER | OPTIONS | COLOUR |
|----------|------|--------|-----------|------------|---------|----------|
| Example: | PS40 | 12 | SA | BS15 | NONE | BLACK-TX |

See first pages for codification details.

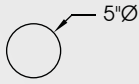

PA50 / PA52 - 5"Ø STRAIGHT POLE, ALUMINUM

POLE

Round, 5" (13cm)Ø, 6061-T6 aluminum shaft, welded to both the top and bottom of a cast aluminum reinforced anchor plate. Hand hole 2" x 5" (8cm x 12cm) with weatherproof cover and copper ground lug.

Handhole 2" x 5" (8cm x 12cm) with weatherproof cover and copper ground lug.

BASE COVER

BS15: Square shape. Two-piece formed aluminium alloy 1100 base cover. Mechanically secured together.

BD_: Round shape. Two-piece base cover made of cast aluminium. Mechanically secured together.

EPA

| | HEIGHT | | WALL THICKNESS | | WEIGHT | | EPA RATING (sq.ft) | | | | | | ANCHOR BOLTS |
|------|--------|------|----------------|-----|--------|----|--------------------|-------|--------|--------|--------|--------|--------------|
| | ft | m | in | mm | lbs | kg | 80mph | 90mph | 100mph | 110mph | 120mph | 150mph | in |
| PA50 | 12 | 3.66 | 0.125 | 3.2 | 36 | 17 | 13.7 | 10.3 | 8.1 | 6.5 | 5.4 | 3.2 | 3/4-20 |
| PA52 | 12 | 3.66 | 0.250 | 6.3 | 61 | 28 | 28.6 | 22.1 | 17.6 | 14.4 | 12.0 | 7.5 | 3/4-20 |
| PA50 | 14 | 4.27 | 0.125 | 3.2 | 41 | 19 | 11.0 | 8.0 | 6.2 | 4.9 | 4.0 | 2.3 | 3/4-20 |
| PA52 | 14 | 4.27 | 0.250 | 6.3 | 70 | 32 | 23.9 | 18.2 | 14.4 | 11.8 | 9.8 | 6.0 | 3/4-20 |
| PA50 | 15 | 4.57 | 0.125 | 3.2 | 43 | 20 | 9.8 | 7.1 | 5.4 | 4.3 | 3.4 | 1.9 | 3/4-20 |
| PA52 | 15 | 4.57 | 0.250 | 6.3 | 74 | 34 | 21.9 | 16.6 | 13.1 | 10.7 | 8.8 | 5.4 | 3/4-20 |
| PA50 | 16 | 4.88 | 0.125 | 3.2 | 45 | 21 | 8.8 | 6.2 | 4.6 | 3.6 | 2.9 | 1.6 | 3/4-20 |
| PA52 | 16 | 4.88 | 0.250 | 6.3 | 79 | 36 | 20.1 | 15.1 | 11.9 | 9.6 | 7.9 | 4.8 | 3/4-20 |
| PA50 | 18 | 5.49 | 0.125 | 3.2 | 50 | 23 | 6.7 | 4.5 | 3.2 | 2.5 | 1.9 | - | 1-36 |
| PA52 | 18 | 5.49 | 0.250 | 6.3 | 87 | 40 | 16.6 | 12.3 | 9.5 | 7.7 | 6.3 | 3.7 | 1-36 |
| PA50 | 20 | 6.10 | 0.125 | 3.2 | 54 | 25 | 5.0 | 3.1 | 2.0 | 1.5 | 1.0 | - | 1-36 |
| PA52 | 20 | 6.10 | 0.250 | 6.3 | 96 | 44 | 13.7 | 10.0 | 7.6 | 6.1 | 4.9 | 2.8 | 1-36 |

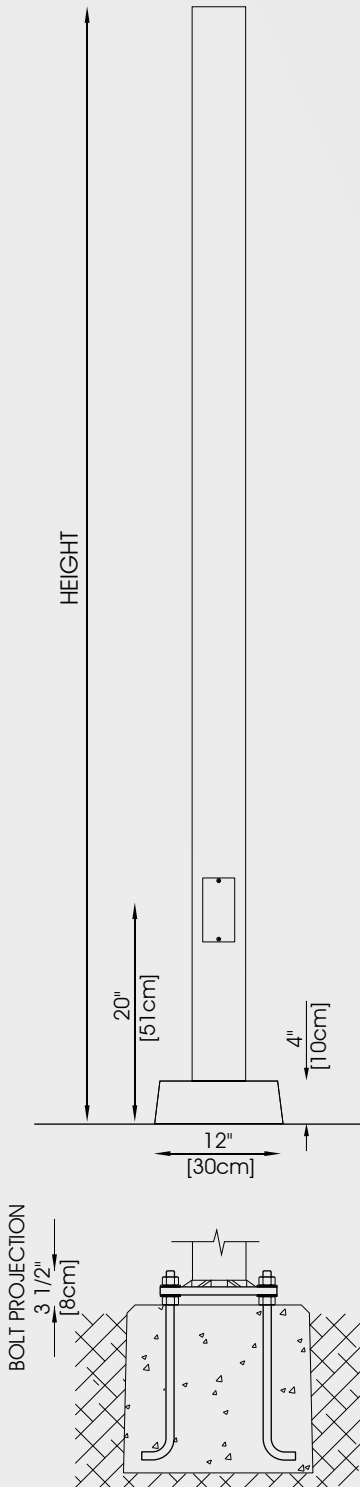

BOLT CIRCLE

Anchor plate (SA)

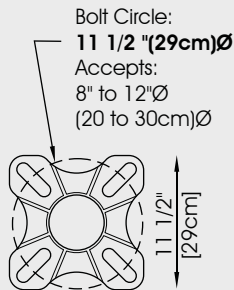

Pole with anchor plate, supplied with galvanized anchor bolts, nuts & washers.

ANCHORAGE

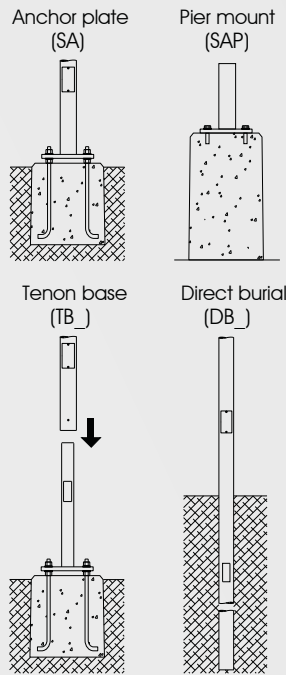

BASE COVERS (examples)

BS16 is shown with the pole. For all models available, see "Pole options" Section.

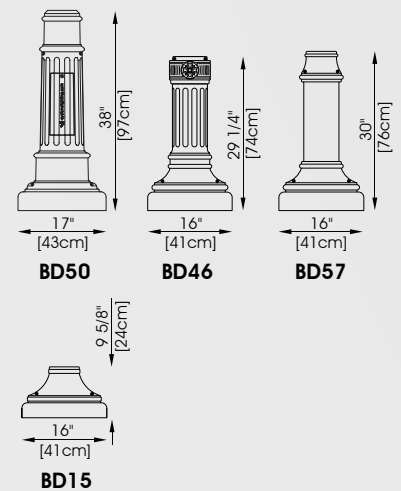

ORDERING TEMPLATE

| | POLE | HEIGHT | ANCHORAGE | BASE COVER | OPTIONS | COLOUR |
|----------|------|--------|-----------|------------|---------|----------|
| Example: | PD12 | 12 | SA | BS15 | NONE | BLACK-TX |

See first pages for codification details.

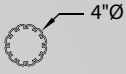

PD12 - 4"Ø STRAIGHT POLE, FLUTTED ALUMINUM

POLE

Round, reinforced fluted shape (12 flutes), 4" (10cm) Ø, 6005-T5 aluminum shaft. Welded to both the top and bottom of a cast aluminum reinforced anchor plate.

Handhole 2" x 5" (8cm x 12 cm) with weatherproof cover and copper ground lug.

BASE COVER

BS15: Square shape. Two-piece formed aluminium alloy 1100 base cover. Mechanically secured together.

BD_: Round shape. Two-piece base cover made of cast aluminium. Mechanically secured together.

EPA

| | HEIGHT | | WALL THICKNESS | | WEIGHT | | EPA RATING (sq.ft) | | | | | | ANCHOR BOLTS |
|-------|--------|------|----------------|-----|--------|----|--------------------|-------|--------|--------|--------|--------|--------------|
| | ft | m | in | mm | lbs | kg | 80mph | 90mph | 100mph | 110mph | 120mph | 150mph | in |
| PD 12 | 8 | 2.44 | 0.125 | 3.2 | 25 | 11 | 16.4 | 12.7 | 10.0 | 8.0 | 6.5 | 3.6 | 3/4-20 |
| PD 12 | 10 | 3.05 | 0.125 | 3.2 | 30 | 14 | 12.7 | 9.6 | 7.5 | 5.8 | 4.6 | 2.3 | 3/4-20 |
| PD 12 | 12 | 3.66 | 0.125 | 3.2 | 35 | 16 | 9.9 | 7.4 | 5.5 | 4.2 | 3.2 | 1.2 | 3/4-20 |
| PD 12 | 13 | 3.96 | 0.125 | 3.2 | 37 | 17 | 8.8 | 6.4 | 4.8 | 3.5 | 2.5 | - | 3/4-20 |
| PD 12 | 14 | 4.27 | 0.125 | 3.2 | 40 | 18 | 7.8 | 5.6 | 4.0 | 2.9 | 2.0 | - | 3/4-20 |
| PD 12 | 15 | 4.57 | 0.125 | 3.2 | 42 | 19 | 6.9 | 4.8 | 3.4 | 2.3 | 1.5 | - | 3/4-20 |
| PD 12 | 16 | 4.88 | 0.125 | 3.2 | 45 | 20 | 6.0 | 4.1 | 2.8 | 1.8 | 1.0 | - | 3/4-20 |
| PD 12 | 18 | 5.49 | 0.125 | 3.2 | 50 | 23 | 4.4 | 2.8 | 1.6 | - | - | - | 1-36 |
| PD 12 | 20 | 6.10 | 0.125 | 3.2 | 55 | 25 | 3.1 | 1.7 | - | - | - | - | 1-36 |

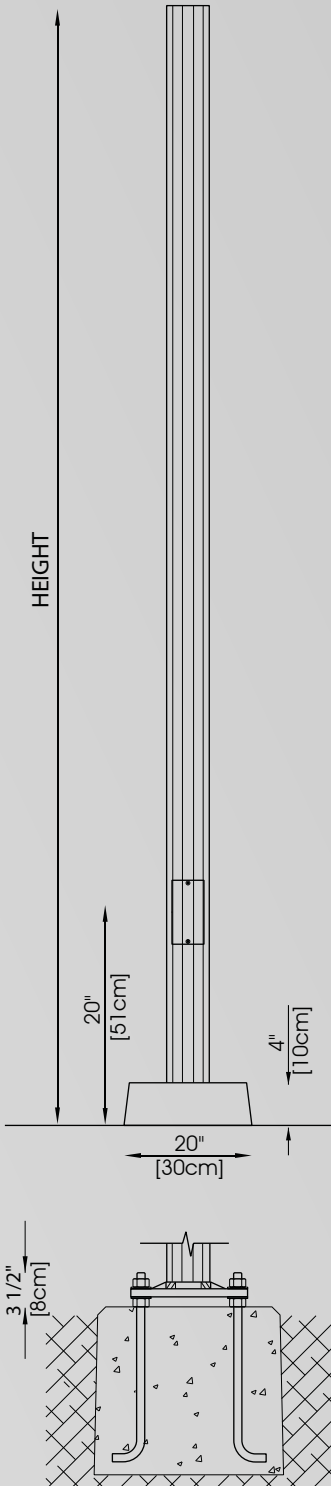

BOLT CIRCLE

Anchor plate (SA)

Bolt Circle:
10" (25cm)Ø
 Accepts:
 7" to 11 1/2"Ø
 (18 to 29cm)Ø

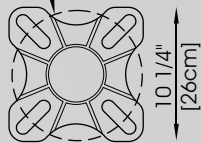

Pole with anchor plate, supplied with galvanized anchor bolts, nuts & washers.

ANCHORAGE

Anchor plate (SA)

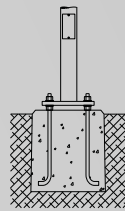

Tenon base (TB_)

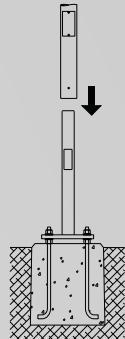

Pier mount (SAP)

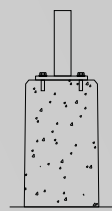

Direct burial (DB_)

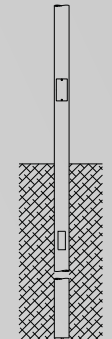

BASE COVERS (examples)

BS15 is shown with the pole.

For all models available, see "Pole options" Section.

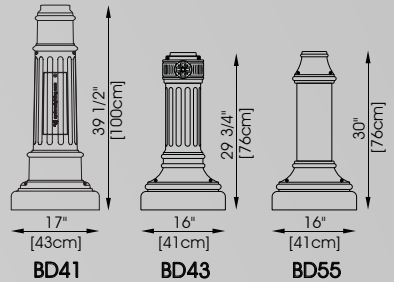

ORDERING TEMPLATE

| | POLE | HEIGHT | ANCHORAGE | BASE COVER | OPTIONS | COLOUR |
|----------|------|--------|-----------|------------|---------|----------|
| Example: | PD15 | 12 | SA | BD50 | NONE | BLACK-TX |

See first pages for codification details.

PD15 - 5"Ø STRAIGHT POLE, FLUTTED ALUMINUM

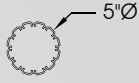

POLE

Round, reinforced fluted shape (12 flutes), 5" (13cm) Ø, 6005-T5 aluminum shaft. Welded to both the top and bottom of a cast aluminum reinforced anchor plate.

Handhole 2" x 5" (8cm x 12 cm) with weatherproof cover and copper ground lug.

BASE COVER

BD_: Round shape. Two-piece base cover made of cast aluminium. Mechanically secured together.

EPA

| | HEIGHT | | WALL THICKNESS | | WEIGHT | | EPA RATING (sq.ft) | | | | | | ANCHOR BOLTS |
|-------|--------|------|----------------|-----|--------|----|--------------------|-------|--------|--------|--------|--------|--------------|
| | ft | m | in | mm | lbs | kg | 80mph | 90mph | 100mph | 110mph | 120mph | 150mph | in |
| PD 15 | 12 | 3.66 | 0.125 | 3.2 | 47 | 21 | 15.3 | 11.5 | 8.8 | 5.8 | 5.3 | 2.3 | 3/4-20 |
| PD 15 | 13 | 3.96 | 0.125 | 3.2 | 50 | 23 | 13.7 | 10.2 | 7.7 | 5.5 | 4.4 | 1.7 | 3/4-20 |
| PD 15 | 14 | 4.27 | 0.125 | 3.2 | 53 | 24 | 12.3 | 9.0 | 6.7 | 5.0 | 3.6 | 1.1 | 3/4-20 |
| PD 15 | 15 | 4.57 | 0.125 | 3.2 | 56 | 25 | 11.1 | 8.0 | 5.8 | 4.2 | 2.9 | - | 3/4-20 |
| PD 15 | 16 | 4.88 | 0.125 | 3.2 | 59 | 27 | 9.9 | 7.0 | 4.9 | 3.4 | 2.3 | - | 3/4-20 |
| PD 15 | 18 | 5.49 | 0.125 | 3.2 | 66 | 30 | 7.6 | 5.2 | 3.4 | 2.1 | 1.1 | - | 1-36 |
| PD 15 | 20 | 6.10 | 0.125 | 3.2 | 72 | 33 | 5.8 | 3.6 | 2.0 | - | - | - | 1-36 |

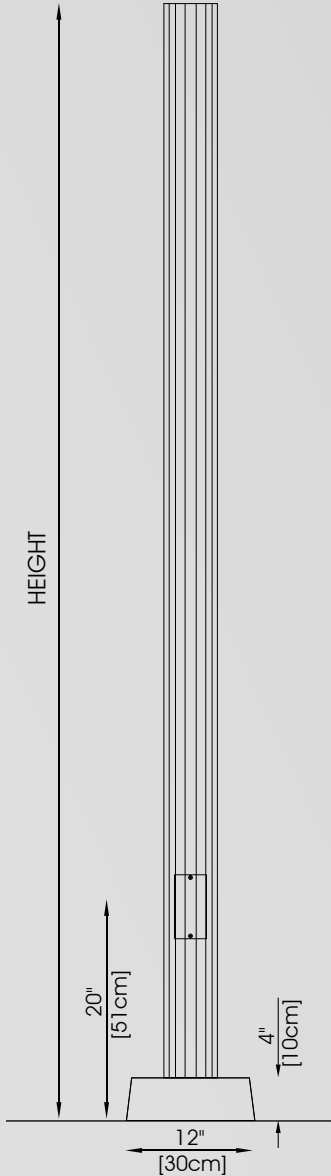

BOLT CIRCLE

Anchor plate (SA)

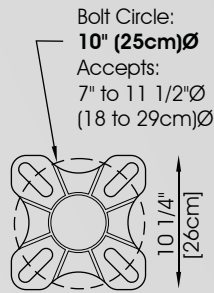

Pole with anchor plate, supplied with galvanized anchor bolts, nuts & washers.

ANCHORAGE

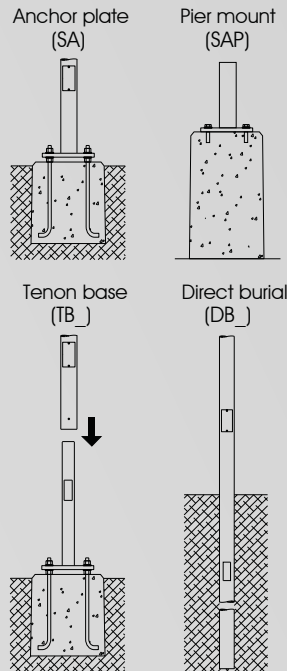

BASE COVERS (examples)

BS16 is shown with the pole.

For all models available, see "Pole options" Section.

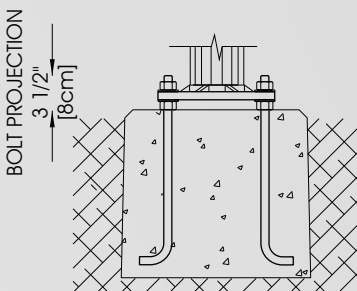
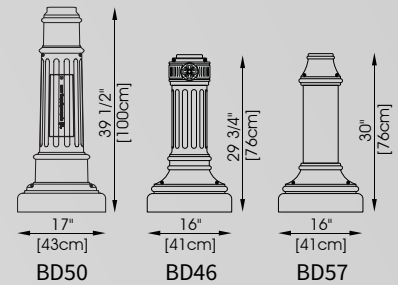

ORDERING TEMPLATE

| | POLE | HEIGHT | ANCHORAGE | BASE COVER | OPTIONS | COLOUR |
|----------|------|--------|-----------|------------|---------|----------|
| Example: | PM40 | 12 | SA | BM11 | NONE | BLACK-TX |

See first pages for codification details.

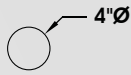

PM40 / PM42 - 4"Ø MUFFLER POLE

POLE

Round, 4" (10cm)Ø, 6061-T6 aluminum shaft, welded to a 6 5/8" (17cm)Ø base. The assembly is welded to both the top and bottom of a cast aluminum reinforced anchor plate.

Handhole 4" x 9" (10cm x 22cm) with weatherproof cover and copper ground lug.

JOINT CORNER

JOINT CORNER: Round shape. Two-piece cover made of cast aluminum. Mechanically secured to the pole junction.

BASE COVER: Round shape. Two-piece base cover made of cast aluminium. Mechanically secured around the pole base.

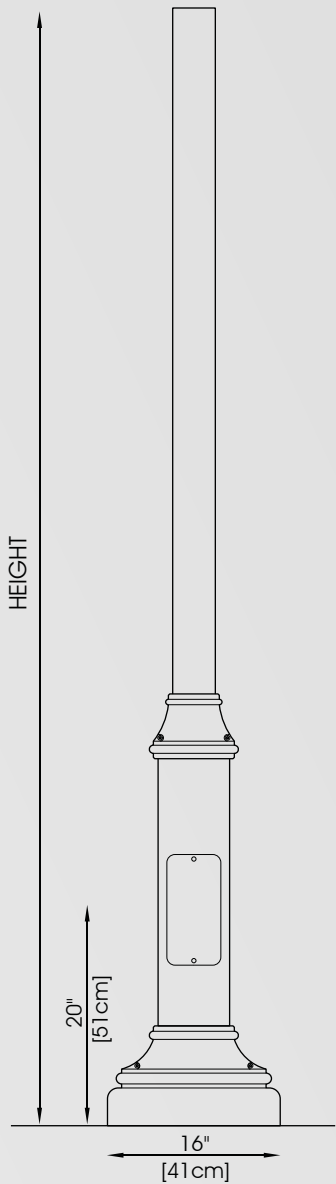

EPA

| | HEIGHT | | WALL THICKNESS | | WEIGHT | | EPA RATING (sq.ft) | | | | | | ANCHOR BOLTS |
|------|--------|------|----------------|-----|--------|----|--------------------|-------|--------|--------|--------|--------|--------------|
| | ft | m | in | mm | lbs | kg | 80mph | 90mph | 100mph | 110mph | 120mph | 150mph | |
| PM40 | 8 | 2.44 | 0.125 | 3.2 | 36 | 16 | 21.1 | 16.4 | 13.1 | 10.7 | 8.9 | 5.6 | 3/4-20 |
| PM42 | 8 | 2.44 | 0.226 | 5.7 | 43 | 20 | 36.6 | 28.8 | 23.1 | 19.0 | 15.8 | 10.1 | 3/4-20 |
| PM40 | 10 | 3.05 | 0.125 | 3.2 | 40 | 18 | 15.2 | 11.7 | 9.3 | 7.5 | 6.1 | 3.8 | 3/4-20 |
| PM42 | 10 | 3.05 | 0.226 | 5.7 | 50 | 23 | 27.0 | 21.1 | 16.9 | 13.7 | 11.4 | 7.2 | 3/4-20 |
| PM40 | 12 | 3.66 | 0.125 | 3.2 | 43 | 20 | 11.5 | 8.7 | 6.8 | 5.4 | 4.3 | 2.6 | 3/4-20 |
| PM42 | 12 | 3.66 | 0.226 | 5.7 | 56 | 25 | 21.0 | 16.2 | 12.9 | 10.4 | 8.5 | 5.3 | 3/4-20 |
| PM40 | 13 | 3.96 | 0.125 | 3.2 | 45 | 20 | 10.1 | 7.6 | 5.8 | 4.5 | 3.6 | 2.1 | 3/4-20 |
| PM42 | 13 | 3.96 | 0.226 | 5.7 | 59 | 27 | 18.7 | 14.4 | 11.4 | 9.1 | 7.4 | 4.5 | 3/4-20 |
| PM40 | 14 | 4.27 | 0.125 | 3.2 | 47 | 21 | 8.9 | 6.6 | 5.0 | 3.8 | 2.9 | 1.7 | 3/4-20 |
| PM42 | 14 | 4.27 | 0.226 | 5.7 | 62 | 28 | 16.8 | 12.9 | 10.1 | 8.0 | 6.5 | 3.9 | 3/4-20 |
| PM40 | 15 | 4.57 | 0.125 | 3.2 | 49 | 22 | 7.8 | 5.7 | 4.2 | 3.1 | 2.4 | 1.3 | 3/4-20 |
| PM42 | 15 | 4.57 | 0.226 | 5.7 | 65 | 29 | 15.1 | 11.5 | 8.9 | 7.0 | 5.6 | 3.4 | 3/4-20 |
| PM40 | 16 | 4.88 | 0.125 | 3.2 | 50 | 23 | 6.9 | 4.9 | 3.6 | 2.6 | 1.9 | - | 3/4-20 |
| PM42 | 16 | 4.88 | 0.226 | 5.7 | 67 | 30 | 13.6 | 10.3 | 7.9 | 6.1 | 4.9 | 2.9 | 3/4-20 |
| PM40 | 18 | 5.49 | 0.226 | 5.7 | 54 | 24 | 4.4 | 2.8 | 1.6 | - | - | - | 1-36 |
| PM42 | 18 | 5.49 | 0.226 | 5.7 | 75 | 34 | 10.2 | 7.3 | 5.3 | 3.8 | 2.8 | 1.4 | 1-36 |
| PM42 | 20 | 6.10 | 0.226 | 5.7 | 81 | 37 | 7.8 | 5.3 | 3.6 | 2.3 | 1.4 | - | 1-36 |

BOLT CIRCLE

Anchor plate (SA)

Bolt Circle:
11 1/2" (25cm)Ø
 Accepts:
 9 1/2" to 12 1/2"Ø
 (24 to 32cm)Ø

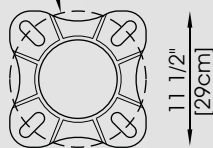

BASE COVERS (examples)

BM11 is shown with the pole.

For all models available, see "Pole options" Section.

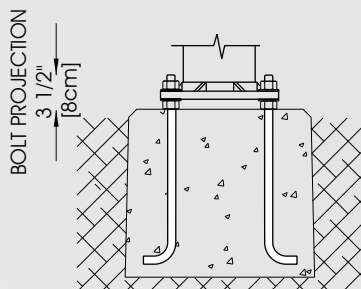
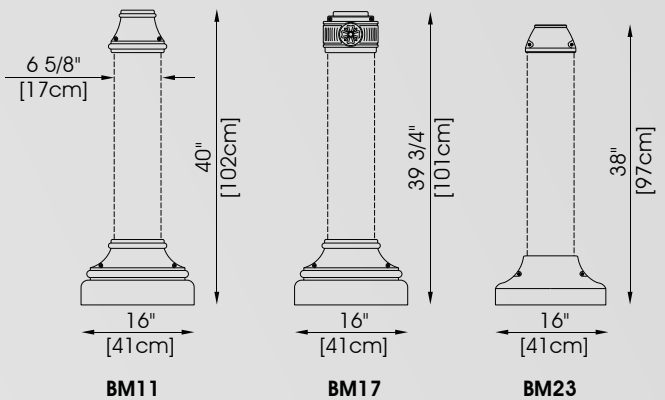

Pole with anchor plate, supplied with galvanized anchor bolts, nuts & washers.

ORDERING TEMPLATE

| | POLE | HEIGHT | ANCHORAGE | BASE COVER | OPTIONS | COLOUR |
|----------|------|--------|-----------|------------|---------|----------|
| Example: | PW15 | 12 | SA | BD81 | NONE | BLACK-TX |

See first pages for codification details.

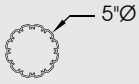

PW15 - 5"Ø STRUCTURAL BASE POLE, FLUTTED ALUMINUM

POLE

Round reinforced fluted shape (12 flutes), 5" (13cm)Ø 6005-T5 aluminum shaft, welded to a structural base incorporating an anchor plate.

Hand hole 4" x 11" (10cm x 28cm) with weatherproof cover and copper ground lug.

BASE COVER

Round shape. Two-piece cover made of cast aluminum. Mechanically secured around the pole base.

EPA

| | HEIGHT | | WALL THICKNESS | | WEIGHT | | EPA RATING (sq.ft) | | | | | | ANCHOR BOLTS |
|------|--------|------|----------------|-----|--------|----|--------------------|-------|--------|--------|--------|--------|--------------|
| | ft | m | in | mm | lbs | kg | 80mph | 90mph | 100mph | 110mph | 120mph | 150mph | in |
| PW15 | 8 | 2.44 | 0.125 | 3.2 | 85 | 39 | 30.0 | 30.0 | 25.4 | 20.8 | 17.3 | 10.7 | 3/4-20 |
| PW15 | 10 | 3.05 | 0.125 | 3.2 | 91 | 41 | 29.1 | 22.7 | 18.1 | 14.7 | 12.1 | 7.2 | 3/4-20 |
| PW15 | 12 | 3.66 | 0.125 | 3.2 | 97 | 44 | 22.3 | 17.2 | 13.6 | 10.9 | 8.8 | 4.9 | 3/4-20 |
| PW15 | 13 | 3.96 | 0.125 | 3.2 | 100 | 45 | 19.8 | 15.2 | 11.8 | 9.4 | 7.5 | 4.0 | 3/4-20 |
| PW15 | 14 | 4.27 | 0.125 | 3.2 | 103 | 47 | 17.6 | 13.4 | 10.4 | 8.1 | 6.4 | 3.2 | 3/4-20 |
| PW15 | 15 | 4.57 | 0.125 | 3.2 | 107 | 49 | 15.8 | 11.9 | 9.1 | 7.0 | 5.5 | 2.5 | 3/4-20 |
| PW15 | 16 | 4.88 | 0.125 | 3.2 | 110 | 50 | 14.1 | 10.5 | 7.9 | 6.0 | 4.6 | 1.9 | 3/4-20 |
| PW15 | 18 | 5.49 | 0.125 | 3.2 | 116 | 53 | 10.0 | 7.0 | 4.8 | 3.2 | 2.0 | - | 1-36 |
| PW15 | 20 | 6.10 | 0.125 | 3.2 | 122 | 55 | 7.2 | 4.6 | 2.8 | 1.4 | - | - | 1-36 |

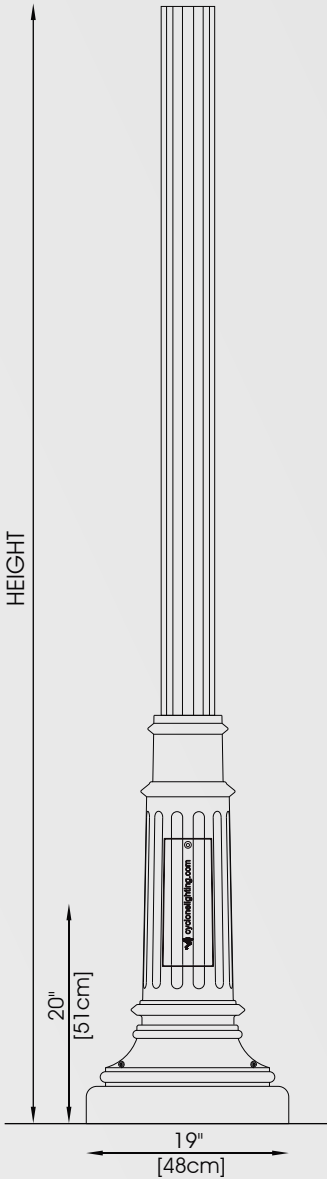

BOLT CIRCLE

Anchor plate (SA)

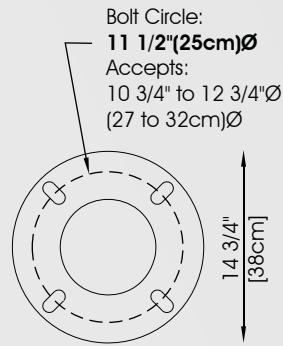

BASE COVERS (examples)

BM11 is shown with the pole.
For all models available, see "Pole options" Section.

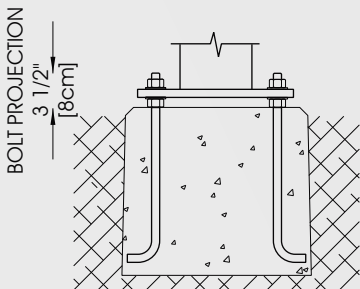
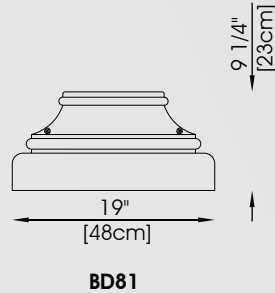

Pole with anchor plate, supplied with galvanized anchor bolts, nuts & washers.

ARMS, POLE AND BASES

This section showcases a vast assortment of mounting arms, poles, and bases. Poles are available in steel or aluminum, with varying wall thickness. Whether classic, traditional or contemporary styling, Cyclone mounting arms, poles and bases combos bring versatility to all types of projects.

BASE COVERS / STANDARD

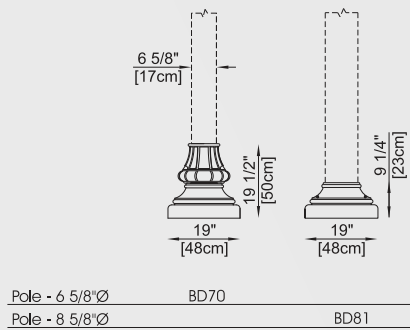
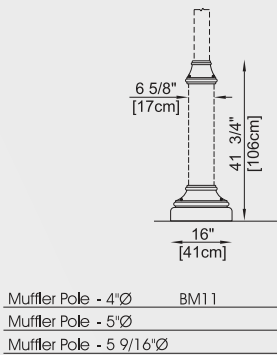
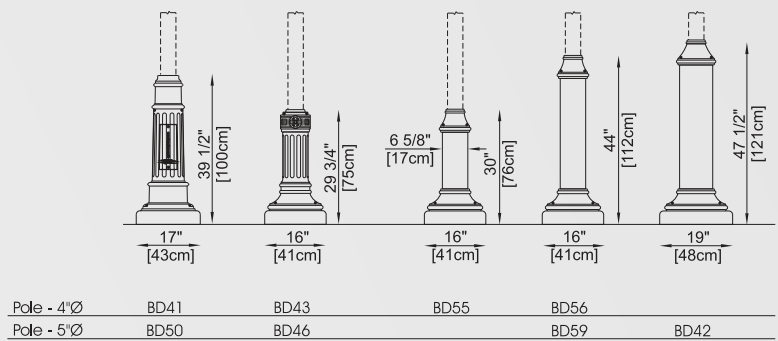
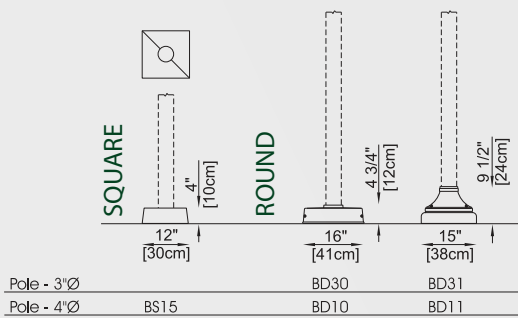

Please consult factory for the specification sheet.

Due to continuous improvement, Cyclone reserves the right to modify these specifications, design and materials of these products without prior notice.

